



Catálogo de
PRODUCTOS

2024





Fabricamos

SOLUCIONES



Serin es una empresa de origen cordobés, que está en actividad desde el año 1983, en el mercado de la construcción.

Con la incorporación de nuevas tecnologías e innovación en nuestros procesos, logramos la excelencia en la calidad de nuestros productos. Basándonos en la experiencia y trayectoria que nos caracteriza en el sector y con el compromiso puesto en la mejora continua, es que consolidamos y ampliamos nuestra visión industrial.

Con la mirada puesta en el crecimiento y desarrollo sostenible, trabajamos con el objetivo de generar un impacto positivo en el medio ambiente. A través de nuestros paneles solares, generamos energía limpia para una industria limpia.

Nuestro equipo de colaboradores trabaja alineado con nuestros valores: honestidad, compromiso, temple y fortaleza, empatía, humildad, familia y comunidad.

Formamos parte de Grupo Serin, una empresa familiar con más de 40 años de experiencia.

En la búsqueda por satisfacer plenamente los requerimientos de cada cliente, las empresas que conforman el Grupo; Serin SA y Servet SA; cumplen con los más altos estándares de calidad, certificados por IRAM según norma IRAM-ISO 9001:2015.

Porque pensamos en proyección, crecimiento, desarrollo sostenible e integridad Serin se respalda en el tiempo, prestando un servicio a la altura de cada uno de nuestros clientes.



Sistema de Gestión de la Calidad
Certificado por IRAM
Norma IRAM-ISO 9001 : 2015

Empresas que nos acompañan:





Productos de

DISTRIBUCIÓN

*Los valores de las tablas a continuación son aproximados.



CHAPA ACANALADA

La chapa acanalada es la solución ideal para la construcción de cubiertas residenciales, comerciales o industriales, así como también para cerramientos laterales.

Su variedad de espesores hace de este producto la solución indicada para cubiertas de viviendas, edificios y galpones.

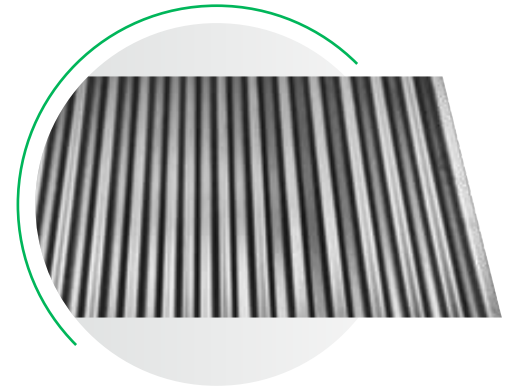

ESPEORES (MM)	ANCHO TOTAL (MM)	ANCHO ÚTIL (MM)	PASO (MM)	ALTURA CRESTA (MM)
0.4	1086	988	76	18
0.5	1086	988	76	18

PESO TEÓRICO APROXIMADO ÚTIL RECUBIERTO (KG/M2)

GALVANIZADO		CINCALUM		PREPINTADO BASE GALVANIZADO		PREPINTADO BASE CINCALUM	
4.07	4.05	4.02	4.00	4.13	4.12	4.06	4.05
5.03	5.01	4.98	4.96	5.10	5.08	5.02	5.00

CHAPA TRAPEZOIDAL T 101

El conformado T101 alcanza excelentes niveles de rendimiento. Indicado en aplicaciones para cerramientos laterales, cubiertas de uso residencial, o naves industriales y galpones.

Descripción:

ESPEORES (MM)	ANCHO TOTAL (MM)	ANCHO ÚTIL (MM)	PASO (MM)	ALTURA CRESTA (MM)
0.4	1100	1010	253	28.5
0.5	1100	1010	253	28.5
0.7	1100	1010	253	28.5

PESO TEÓRICO APROXIMADO ÚTIL RECUBIERTO (KG/M2)

GALVANIZADO		CINCALUM		PREPINTADO BASE GALVANIZADO		PREPINTADO BASE CINCALUM	
4.01	4.05	3.96	4.00	4.07	4.12	4.00	4.05
4.95	5.01	4.91	4.96	5.02	5.08	4.95	5.00
6.85	6.92	6.80	6.87	6.92	6.99	6.84	6.92

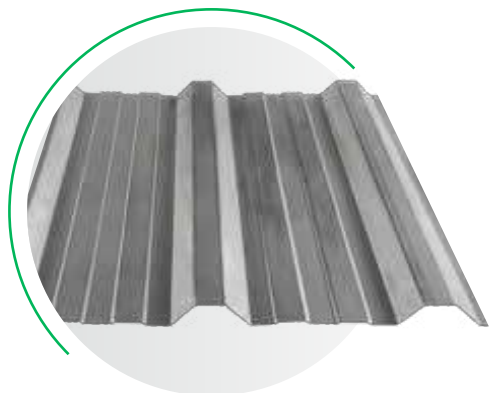



CHAPA TRAPEZOIDAL T90

Usado principalmente para la construcción de cubiertas con requerimientos exigentes de cargas. Este producto permite disminuir los apoyos y, en ciertas ocasiones, hasta eliminarlos, alcanzando considerables reducciones de la estructura del techo.

Descripción:

ESPESORES (MM)	ANCHO TOTAL (MM)	ANCHO ÚTIL (MM)	PASO (MM)	ALTURA CRESTA (MM)
0.5	951	900	450	122
0.7	951	900	450	122

PESO TEÓRICO APROXIMADO ÚTIL RECUBIERTO (KG/M2)							
GALVANIZADO		CINCALUM		PREPINTADO BASE GALVANIZADO		PREPINTADO BASE CINCALUM	
5.47	5.01	5.42	4.96	5.55	5.08	5.47	5.00
7.57	6.92	7.51	6.87	7.64	6.99	7.56	6.92
9.66	8.84	9.61	8.79	9.74	8.91	9.66	8.83

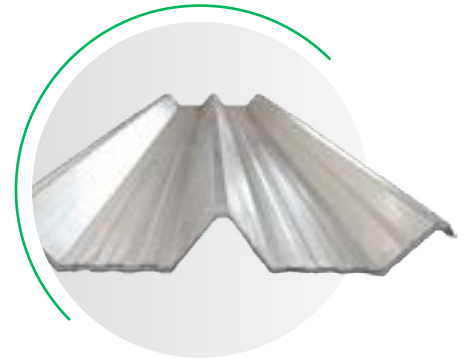

CHAPA PLÁSTICA BLANCA

Descripción:

TIPO	GRAMOS DE FIBRA DE VIDRIO X M	ESPESOR (MM)
CONFORMADO: ACANALADO Y TRAPEZOIDAL *T1010	0.450*	0,90 a 1,20*
	0.600*	1,20 a 1,45*

*Conformado según especificaciones Ternium. Índice de traslúcido: blanco 75%. Nota: estos espesores son aproximados. Consultar condiciones.

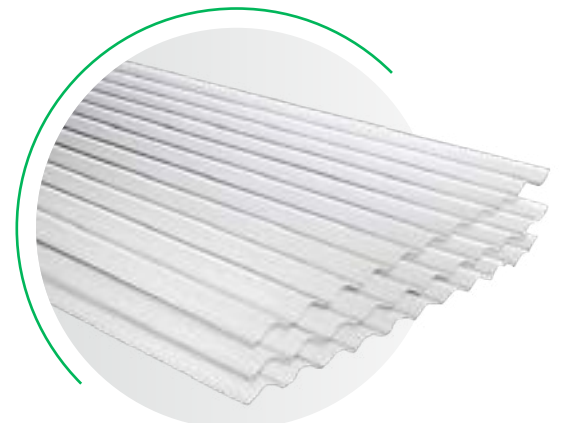



TORNILLOS AUTOPERFORANTES



DESCRIPCIÓN	DIMENSIÓN
TORNILLOS AUTOPERFORANTES X 1000 UDS.	14 X 1
	14 X 1 1/2
	14 X 2
	14 X 2 1/2

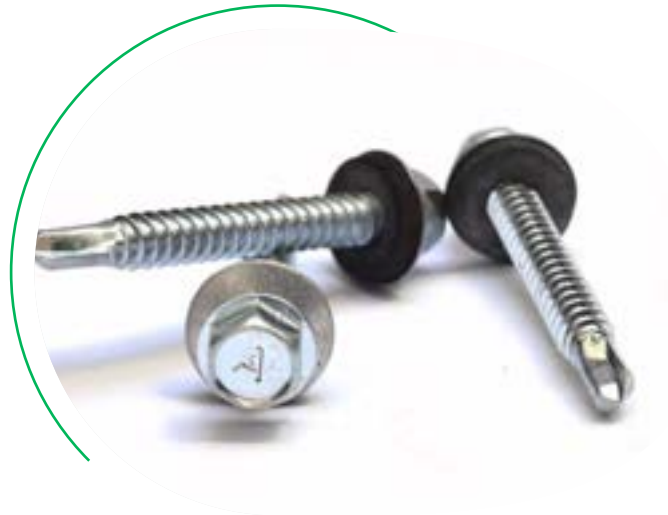

MEMBRANA DE ESPUMA DE POLIETILENO



PRODUCTO	DESCRIPCIÓN	ESPESOR	LARGO DEL ROLLO
MEMBRANA	ALUMINIO SIMPLE CARA	10 MM	20 M
MEMBRANA	ALUMINIO DOBLE CARA	10 MM	20 M
MEMBRANA	ALUMINIO SIMPLE CARA	2 MM	20 M
MEMBRANA	ALUMINIO SIMPLE CARA	5 MM	20 M

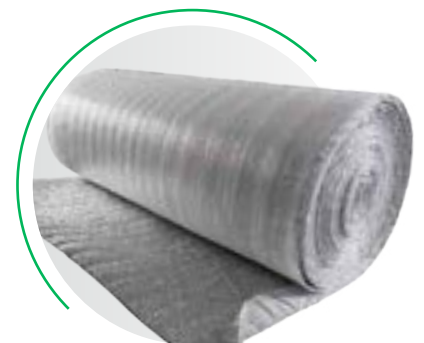

*Consultar largo variable.



CHAPAS LAMINADAS EN CALIENTE LISAS



DESCRIPCIÓN	DIMENSIONES			PESO
	E			
	MM	M	M	KG/M ²
LAC 1"	25,4	1,5	3	196,3
	25,4	1,5	6	196,3
LAC 3/4"	19,5	1,5	3	157
	19,5	1,5	6	157
LAC 5/8"	15,5	1,5	3	121,68
	15,5	1,5	6	121,68
LAC 1/2"	12,5	1,5	3	98,15
	12,5	1,5	6	98,15
LAC 3/8"	9,5	1,5	3	74,6
	9,5	1,5	6	74,6
LAC 5/16"	8	1,5	3	62,8
	8	1,5	6	62,8

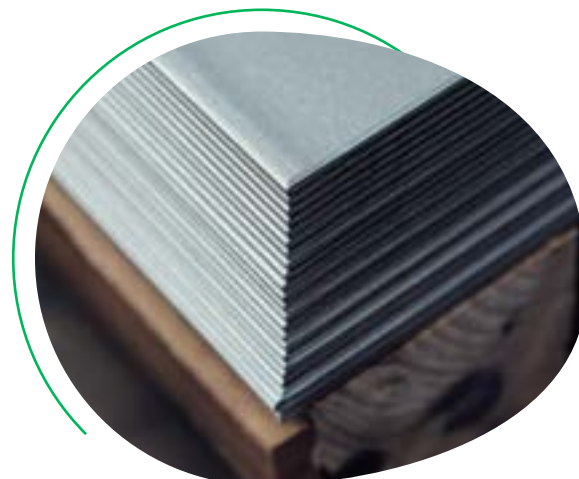



MALLAS ELECTROSOLDADAS DE OBRA



DESCRIPCIÓN	DIMENSIONES			
	SEPARACIÓN LONGITUDINAL	SEPARACIÓN TRANSVERSAL	CALIBRE	MEDIDA MALLA
	CM	CM	MM	M
MINI MALLA Q131	15	15	5	2,4X3
MINI MALLA R131	15	25	5	2,4X3
MALLA Q131	15	15	5	2,4X6
MALLA R131	15	25	5	2,4X6
MALLA Q188	15	15	6	2,4X6
MALLA R188	15	25	6	2,4X6
MALLA Q335	15	15	8	2,4X6
MALLA Q524	15	15	10	2,4X6

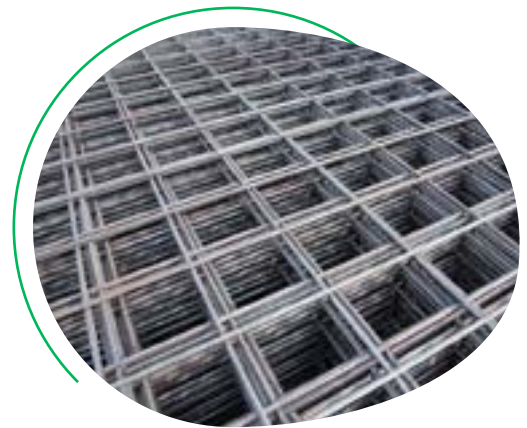

ACERO DN A-420



CÓDIGO	DESCRIPCIÓN (MM)							
ADN	6	8	10	12	16	20	25	32
PESO POR BARRA APROX	2.66	4.74	7.40	10.66	18.96	29.64	46.20	75.7
ADN EN ROLLO	6	8	10	12	16			

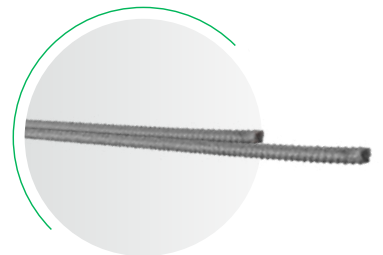

*Barras x 12 m.

HIERRO LISO AL 220



Descripción:

CÓDIGO	DESCRIPCIÓN (MM)							
BARRA	6	8	10	12	14	16	20	25
PESO POR BARRA APROX	2.60	4.74	7.40	10.66	15.10	18.96	29.64	46.20



*Barras x 12 m.



METAL DESPLEGADO LIVIANO



DESCRIPCIÓN	N	DIMENSIONES	
		M	M
LIVIANO	300	0,75	2,00
MEDIANO	420	0,75	2,00
PESADO	600	0,75	2,00

*N= kg x m.

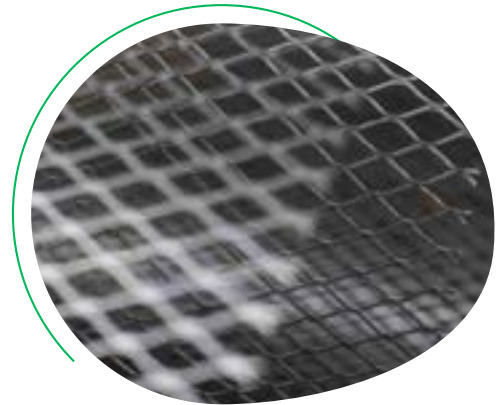

PERFILES IPN



*Consultar por Perfil W.

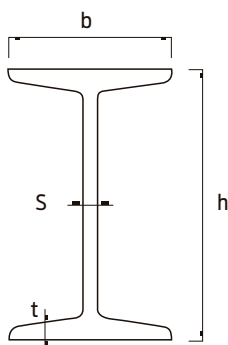

*IPN 80, 100 y 120, de 6 m y 12 m de longitud.

*Mayor de 120 de 12 m de longitud.

Descripción:

DIMENSIONES				SECCIÓN	PESO
H	B	S	T	S	G
MM	MM	MM	MM	CM ²	KG/M
80	42	3,9	5,9	7,6	5,9
100	50	4,5	6,8	10,6	8,3
120	58	5,1	7,7	14,2	11,2
140	66	5,7	8,6	18,3	14,3
160	74	6,3	9,5	22,8	17,9
180	82	6,9	10,4	27,9	21,9
200	90	7,5	11,3	33,5	26,2
220*	98	8,1	12,2	39,6	31,1
240*	106	8,7	13,1	46,1	36,2
260*	113	9,4	14,1	53,3	41,9
280*	119	10,1	15,2	61,0	47,9
300*	125	10,8	16,2	69,1	54,2
320*	131	11,5	17,3	77,7	61,0
340*	137	12,2	18,3	86,7	68,0
360*	143	13,0	19,5	97	76,0
380*	149	13,7	20,5	107	84,0
400*	155	14,4	21,6	118	92,4
425*	163	15,3	23,0	132	104
450*	170	16,2	24,3	147	115
475*	178	17,1	25,6	163	128
500*	185	18,0	27,0	179	141
550*	200	19,0	30,0	212	166
600	215	21,6	32,4	254	199

* Consultar condiciones.



PERFILES UPN



Descripción:

DIMENSIONES				SECCIÓN	PESO
H	B	S	T	S	G
MM	MM	MM	MM	CM ²	KG/M
80	45	6,0	8,0	11,0	8,6
100	50	6,0	8,5	13,5	10,6
120	55	7,0	9,0	17,0	13,3
140	60	7,0	10,0	20,4	16,0
160	65	7,5	10,5	24,0	18,8
180	70	8,0	11,0	28,0	21,9
200	75	8,5	11,5	32,2	25,2
220*	80	9,0	12,5	37,4	29,3
240*	85	9,5	13,0	42,3	33,1
260*	90	10,0	14,0	48,3	37,8
280*	95	10,0	15,0	53,3	41,8
300*	100	10,0	16,0	58,8	46,1
320*	100	14,0	17,5	75,8	59,4
350*	100	14,0	16,0	77,3	60,6
380*	102	13,5	16,0	80,4	63,0
400*	110	14,0	18,0	91,5	71,7

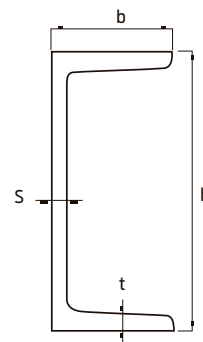

*UPN 80, 100 y 120. 6 m y 12 m de longitud.

*Mayor de 120 de 12 m de longitud.

*Consultar condiciones
**Consultar por perfiles W.

CONCERTINA



DESCRIPCIÓN

DOBLE
CRUZADA
C45

PACK

X 8 M
APROX.



ALAMBRE ALTA RESISTENCIA



DESCRIPCIÓN

ALAMBRE A/R 2,2 MM

ALAMBRE A/R 2,5 MM

PACK

X 100 - X 500 - X 1000 M

X 1000 M





PERFILES C NEGRO Y GALVANIZADO



Descripción:

DIMENSIONES				SECCIÓN	PESO	
H	B	D	T		NEGRO	GALVANIZADO
MM	MM	MM	MM	S CM ²	G KG/M	
80	40	15	1,60	2,84	2,23	2,27
80	40	15	2	3,48	2,77	2,81
80	40	15	3,20	5,26	4,12	
80	50	15	1,60	3,16	2,48	2,52
80	50	15	2	3,88	3,08	3,13
80	50	15	3,20	5,90	4,63	
100	40	10	1,60	3,32	2,50	2,55
100	40	10	2	4,08	3,11	3,16
100	40	10	3,20	6,22	4,70	
100	50	15	1,60	3,48	2,73	2,78
100	50	15	2	4,28	3,40	3,45
100	50	15	3,20	6,54	5,18	
120	50	15	1,60	3,80	2,98	3,04
120	50	15	2	4,68	3,71	3,77
120		15	3,20	7,18	5,68	5,74
140	60	20	2	5,68	4,50	4,56
140	60	20	3,20	8,78	6,89	6,96
160	60	20	2	6,08	4,81	4,88
160	60	20	3,20	9,45	7,44	7,52
180	70	20	2	6,88	5,41	5,49
180	70	20	3,20	10,70	8,40	8,48
200	80	20	2	7,68	5,88	5,97
200	80	20	3,20	11,98	9,41	9,50
220	80	20	2	8,08	6,35	6,45
220	80	20	3,20	12,62	9,96	10,06
240	80	25	3,20	13,41	10,71	10,82

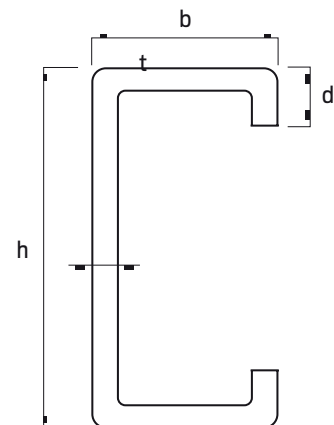
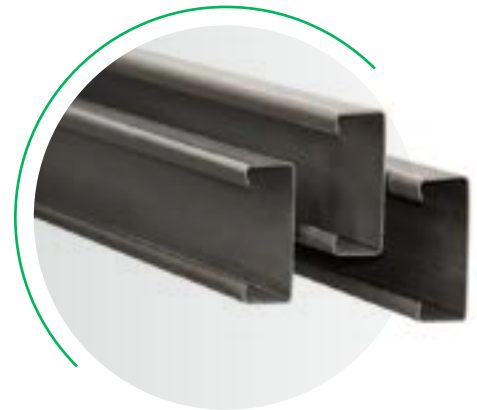

*12 m de longitud. Consultar por longitudes variables.



CERCOS RÍGIDOS



Descripción:

DIÁMETRO	MALLA	LONGITUD	ALTURA	Nº DE PLIEGUES	POSTES COMPLEMENTARIOS	KITS DE SUJECCIÓN
MM	MM	MM	MM			
5,00	200 x 55	2500	1025	2	SI	SI
			1525	3		
			2025	4		

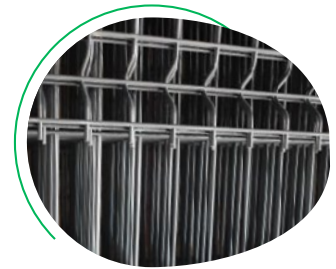

MALLAS ELECTROSOLDADAS EN PANEL



Descripción:

SEPARACIÓN CUADRÍCULA	COLOR	ESPESOR	DIMENSIONES	
		MM	M	M
25 x 25 MM	NEGRA	2,6	1,20	3,00
50 x 50 MM	NEGRA	2,6	1,20	3,00
50 x 50 MM	GALVANIZADA	2,6	1,20	3,00
25 x 25 MM	GALVANIZADA	2,6	1,20	3,00

*Consultar por malla en rollo.

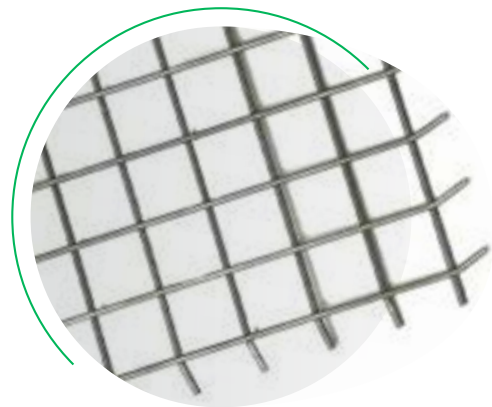

GANCHOS TENSORES



Descripción:

DIMENSIÓN	LONGITUD	PACK
PULG	MM	UNIDADES
5/16	200	50
5/16	250	50
3/8	200	50
3/8	250	50
GRAMPA U		50

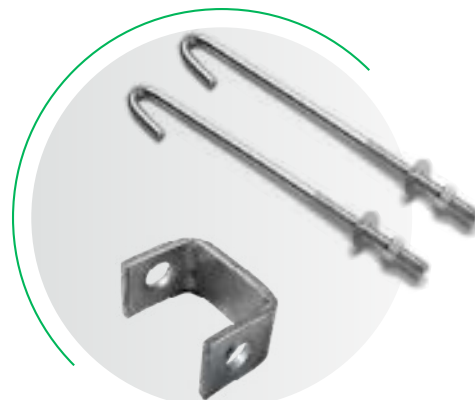



CHAPAS PERFORADAS

DESCRIPCIÓN	PERFORACIÓN	CALIBRE	DIMENSIÓN	
			M	M
REDONDA	3 MM	20	1,00	2,00
REDONDA	5 MM	20	1,00	2,00

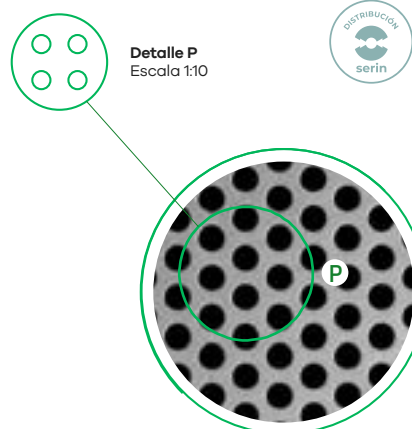

*Medidas y diseños en stock. Consulte por otras medidas y diseños.
 **Se entregan en material crudo. Consulte por perforadas decorativas a pedido.

CHAPAS PERFORADAS DECORATIVA

DESCRIPCIÓN
CHAPA PERF. R/LUNARES COMB 20 1X2 SERIN
CHAPA PERF. C/CUADRÍCULA 20 1X2 SERIN
CHAPA PERF. C/TETRIX 20 1X2 SERIN
CHAPA PERF. R/COSMOS 20 1X2 SERIN



*Medidas y diseños en stock.
 Consultar por otras medidas y diseños. Se entregan en material crudo.

METAL DESPLEGADO PESADO

DESCRIPCIÓN	D	E	N	DIMENSIÓN	
				M	M
270 - 16 - 20	27 MM	1,60 MM	2 MM	1,50	3,00
300 - 30 - 30	33 MM	3,20 MM	3 MM	1,50	3,00
450 - 30 - 30	45 MM	3,20 MM	3 MM	1,50	3,00
620 - 30 - 30	62 MM	3,20 MM	3 MM	1,50	3,00
620 - 30 - 60	62 MM	3,20 MM	6 MM	1,50	3,00
GRANADA	70 MM	2,00 MM	3 MM	1,50	2,00

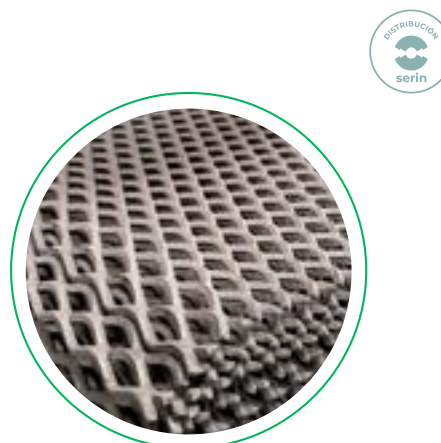

*Medidas en stock.
 **Consultar por otras medidas.



BARRAS REDONDAS



Descripción:

DIMENSIONES		SECCIÓN	PESO
D		S	G
PULG.	MM	CM ²	KG/M
1/4	6,35	0,32	0,25
5/16	7,94	0,49	0,39
3/8	9,53	0,71	0,56
7/16	11,11	0,97	0,76
1/2	12,70	1,27	0,99
9/16	14,29	1,60	1,26
5/8	15,88	1,98	1,55
3/4	19,05	2,85	2,24
7/8	22,23	3,88	3,05
1	25,40	5,07	3,98

*6 m de longitud.

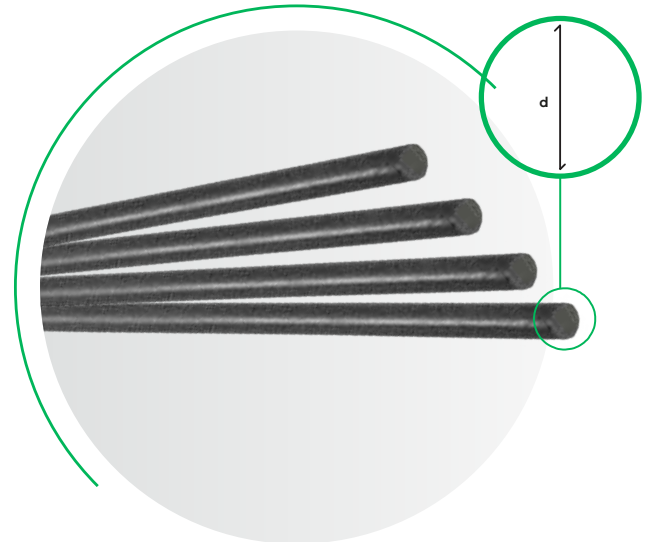

BARRAS CUADRADAS



Descripción:

DIMENSIONES		SECCIÓN	PESO
A		S	G
PULG.	MM	CM ²	KG/M
5/16	7,94	0,63	0,49
3/8	9,53	0,91	0,71
7/16	11,11	1,23	0,97
1/2	12,70	1,61	1,27
9/16	14,29	2,04	1,60
5/8	15,88	2,52	1,98
3/4	19,05	3,63	2,85
7/8	22,05	4,94	3,88

*6 m de longitud.

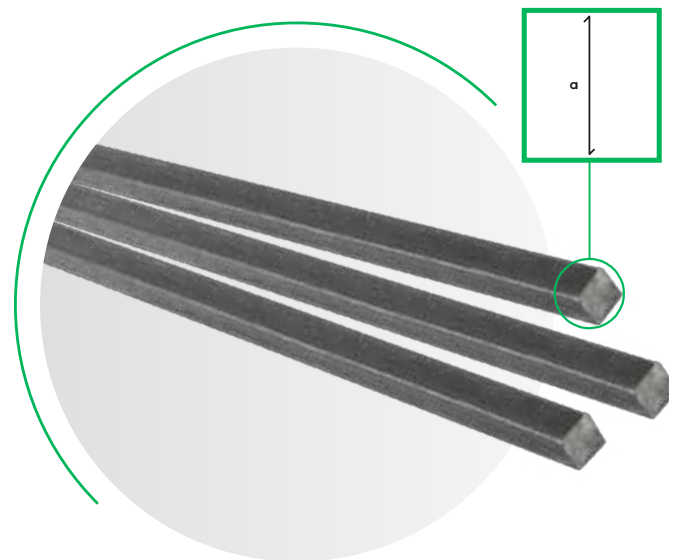



ALAMBRES COBREADOS



Descripción:

TIPO	PRESENTACIÓN	DIMENSIÓN	
M.I.G.	15 KG	0,90 MM	1,20 MM
M.I.G.	15 KG	1,20 MM	1,20 MM
M.I.G.	15 KG	1,60 MM	1,20 MM



ELECTRODOS



Descripción:

TIPO	PRESENTACIÓN	DIÁMETRO
6013	30 KG	2,00 MM
6013	30 KG	2,50 MM
6013	30 KG	3,25 MM
6013	30 KG	4.00 MM





PLANCHUELAS LAMINADAS



Descripción:

DIMENSIONES										
A		E								
PULG.	MM	1/8"	3/16"	1/4"	5/16"	3/8"	1/2"	5/8"	3/4"	1"
		3,2 MM	4,8 MM	6,4 MM	7,9 MM	9,5 MM	12,7 MM	15,9 MM	19,1 MM	25,4 MM
1/2	12,7	0,32	0,47	0,63						
5/8	15,9	0,40	0,59	0,79						
3/4	19,1	0,48	0,71	0,95	1,19	1,42				
7/8	22,2	0,55	0,83	1,11	1,38					
1	25,4	0,63	0,95	1,27	1,58	1,90	2,53			
1 1/4	31,7	0,79	1,19	1,58	1,98	2,37	3,17			
1 1/2	38,1	0,95	1,42	1,90	2,37	2,85	3,80			
1 3/4	44,4	1,11	1,66	2,22	2,77	3,32	4,43			
2	50,8	1,27	1,90	2,53	3,17	3,80	5,06	6,33	7,60	
1 1/4	57,2	1,42	2,14	2,85						
2 1/2	63,5	1,58	2,37	3,17	3,96	4,75	6,33	7,92	9,50	
3	76,2	1,90	2,85	3,80	4,75	5,69	7,60	9,50	11,40	15,19
3 1/2	88,9	2,22	3,32	4,43						
4	101,6	2,53	3,80	5,06	6,33	7,59	10,13	12,67	15,19	20,26
5	127,0	3,17	4,75	6,33	7,91	9,49	12,66	15,83	18,99	25,32
6	152,4	3,80	5,70	7,60	9,50	11,39	15,19	19,00	22,79	30,39

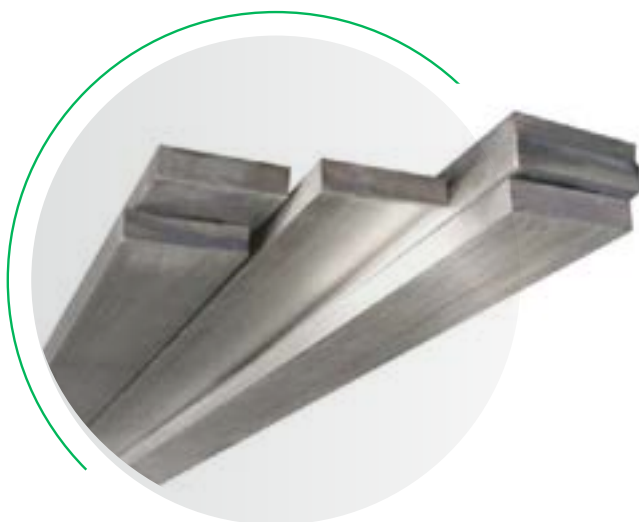

*6 m de longitud hasta 3 x 1".
Los valores indican peso por
unidad de longitud (kg/m).

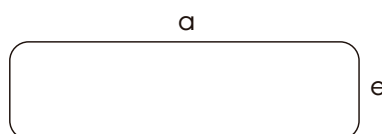



PERFILES ÁNGULO DE ALAS IGUALES



Descripción:

DIMENSIONES				SECCIÓN	PESO
A		E		S	G
PULG.	MM	PULG.	MM	CM ²	KG/M
1/2"	12,7	1/8"	3,2	0,71	0,55
5/8"	15,9	1/8"	3,2	0,94	0,74
3/4"	19,1	1/8"	3,2	1,13	0,89
7/8"	22,2	1/8"	3,2	1,32	1,04
1"	25,4	1/8"	3,2	1,51	1,19
1"	25,4	3/16"	4,8	2,19	1,72
1 1/4"	31,8	1/8"	3,2	1,97	1,55
1 1/4"	31,8	3/16"	4,8	2,87	2,25
1 1/2"	38,1	1/8"	3,2	2,37	1,86
1 1/2"	38,1	3/16"	4,8	3,46	2,71
1 1/2"	38,1	1/4"	6,4	4,49	3,53
1 3/4"	44,5	1/8"	3,2	2,83	2,22
1 3/4"	44,5	3/16"	4,8	4,14	3,25
1 3/4"	44,5	1/4"	6,4	5,40	4,24
2"	50,8	1/8"	3,2	3,21	2,52
2"	50,8	3/16"	4,8	4,72	3,70
2"	50,8	1/4"	6,4	6,17	4,84
2 1/4"	57,2	3/16"	4,8	5,31	4,17
2 1/4"	57,2	1/4"	6,4	6,96	5,46
2 1/2"	63,5	3/16"	4,8	6,00	4,71
2 1/2"	63,5	1/4"	6,4	7,87	6,18
3"	76,2	1/4"	6,4	9,43	7,40
3"	76,2	5/16"	7,9	11,49	9,02
3"	76,2	3/8"	9,5	13,64	10,71
3 1/2"	88,9	1/4"	6,4	11,11	8,72
3 1/2"	88,9	5/16"	7,9	13,57	10,65
3 1/2"	88,9	3/8"	9,5	16,14	12,67
4"	101,6	1/4"	6,4	12,80	10,05
4"	101,6	5/16"	7,9	15,65	12,28
4"	101,6	3/8"	9,5	18,63	14,63
4"	101,6	1/2"	12,7	24,45	19,19
5"	127,0	3/8"	9,5	23,44	18,40
5"	127,0	1/2"	12,7	30,86	24,22

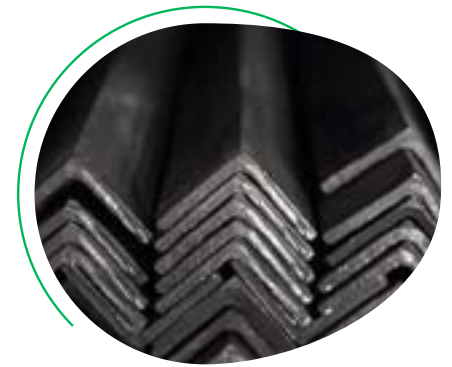

*6 m de longitud.

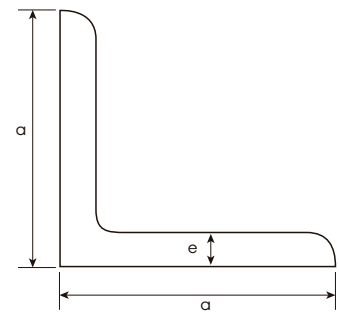



HIERRO T



Descripción:

DIMENSIONES				KG/M
A		B		
PULG.	MM	PULG.	MM	
3/4	19,1	1/8	3,2	0,89
7/8	22,2	1/8	3,2	1,04
1	25,4	1/8	3,2	1,19
1 1/4	31,8	1/8	3,2	1,54
1 1/2	38,1	1/8	3,2	1,84
1 3/4	31,8	3/16	4,8	2,27
1 1/2	38,1	3/16	4,8	2,72
2	50,8	3/16	4,8	3,69
2	50,8	1/4	6,4	4,87

*6 m de longitud.

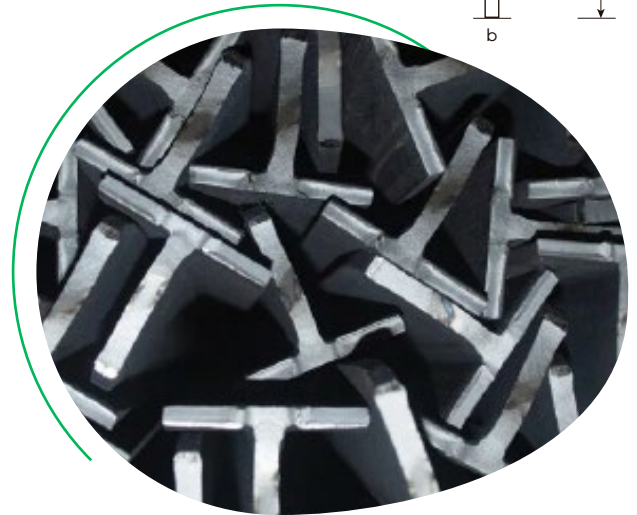
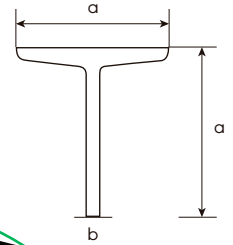

PERFIL U CHICO



Descripción:

DESCRIPCIÓN	DIMENSIONES			PESO
	H	B	S	G
	M	MM	MM	KG/M
40	40	20	5	2,87
50	50	25	5	3,86
50	50	38	5	5,07
60	60	30	6	5,59
65	65	42	5,5	7,09

*6 m de longitud.

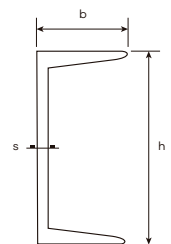



TUBOS PARA USO ESTRUCTURAL



Descripción:

FAMILIA	RED. MM	CUAD. MM	RECT. MM	LIVIANOS - ESPESOR (MM)													
				LAMINADOS EN FRÍO, DECAPADOS				LAMINADOS EN CALIENTE, SIN DECAPAR									
				0,8	0,9	1,25	1,6	1,6	2	2,5	3,2	3,6	4,75				
1/2				0,235	0,262	0,341											
		10x10		0,235	0,262	0,341											
1 7/8	47,62			0,925	1,038	1,375	1,818	1,818	2,253								
			25x50	0,925	1,038	1,375		1,818	2,253								
2	50,80										2,981	3,671					
		40x40									2,981	3,671					
			20x60								2,981	3,671					
			30x50								2,981	3,671					
2 1/4	57,15										3,373	4,263					
		45x45									3,373	4,263					
			30x60								3,373	4,263					
			40x50								3,373	4,263					
2 1/2	63,50										3,765	4,764					
		50x50									3,765	4,764		5,877			
			30x70								3,765	4,764					
			40x60								3,765	4,764		5,877			
3	72,60				1,673	1,25	2,947	2,947	3,664	4,549	5,768						
		60x60				2,222		2,947	3,664	4,549	5,768						
			20x100			2,222		2,947	3,664								
			40x80			2,222		2,947	3,664	4,549	5,768						
			50x70			2,222		2,947	3,664	4,549	5,768						
3 1/2	88,90					2,222	3,449	3,449	4,291	5,333	6,771	7,582					
		70x70				2,599		3,449	4,291	5,333	6,771	7,582					
			40x100			2,599		3,449	4,291	5,333	6,771	7,582					
			60x80			2,599		3,449	4,291	5,333	6,771	7,582					
3 3/4	95,22		50x100			2,599		3,700	4,605	5,725	7,273						
4	101,60								3,951	4,919	6,117	7,775					
		80x80	40x120						3,951	4,919	6,117	7,775					
			60x100						3,951	4,919	6,117	7,775					
									3,951	4,919	6,117	7,775					
4 1/2	114,30								4,452	5,546	6,901	8,778	9,840	10,894			
		90x90							4,452	5,546	6,901	8,778		10,894			
			60x120						4,452	5,546	6,901	8,778		10,894			
			80x100						4,452	5,546	6,901	8,778		10,894			
5	127,00								4,954	6,173	7,685	9,782					
									4,954	6,173	7,685	9,782					
			50x150						4,954	6,173	7,685	9,782					
		100x100	60x140						4,954	6,173	7,685	9,782					
			80x120						4,954	6,173	7,685	9,782					

*6 m de longitud. Tabla de peso por unidad de longitud (kg/m).





TUBOS PARA USO MECÁNICO



Descripción:

DIÁMETRO		ESPEORES (MM)				
NOMINAL	EXTERIOR	LAMINADOS EN CALIENTE, SIN DECAPAR				
PULG.	MM	2,35	2,9	3,2	3,6	4
1/2	21,30	1,101				
3/4	26,70	1,426				
1	33,40		2,208			
1 1/4	42,20		2,832			
1 1/2	48,30		3,255			
2	60,30		4,043	4,573		
2 1/2	76,10		5,162	5,839		
3	88,90			6,771	7,674	
4	114,30				9,840	11,012

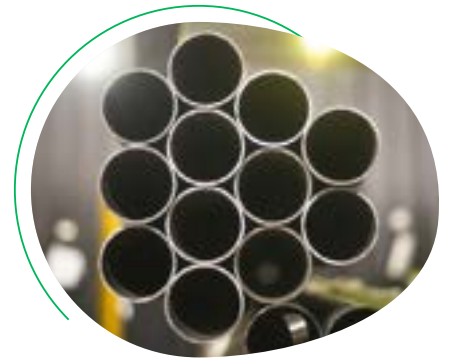

*6,40 m de longitud. Tabla de peso por unidad de longitud. (kg/m)

VARILLAS ROSCADAS



Descripción:

DESCRIPCIÓN	DIMENSIONES											
	3/19	5/16	1/2	3/4	9/16	7/8	1/4	3/8	5/8	7/16	5/32	1
VARILLA ROSCADA	3/16	5/16	1/2	3/4	9/16	7/8	1/4	3/8	5/8	7/16	5/32	1
VARILLA ROSCADA GALVANIZADA	3/16	5/16	1/2	3/4	9/16	7/8	1/4	3/8	5/8	7/16	5/32	1

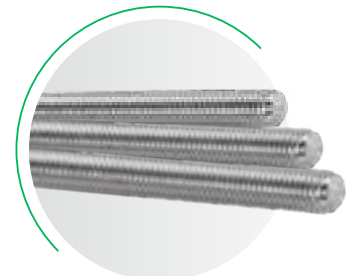

CLAVOS CABEZA DE PLOMO



Descripción:

DIMENSIÓN		PACK
LONGITUD		
PULG.	MM	BOLSAS X 100 U
2 1/2	63,5	22
3	76,2	20
4	101,6	14





(0351) 414 1900



351 200 3268
351 686 3231

PLANTA INDUSTRIAL Y CENTRO MAYORISTA CÓRDOBA: AV. JUAN B JUSTO 8500

CENTRO MAYORISTA PILAR: RUTA 25 ESQ. EL TROPERO

PLANTA INDUSTRIAL RAMALLO: AV. CENTRAL ACERO ARGENTINO ESTE 735

PLANTA INDUSTRIAL LOMAS DE ZAMORA: LAUREANO OLIVER 1685

PLANTA INDUSTRIAL SAN LUIS: RUTA 3 SUR KM 1

ASESORAMIENTO@GRUPOSERIN.COM.AR



WWW.SERIN.COM.AR
WWW.GRUPOSERIN.COM.AR